

X SERIES

HORIZONTAL INTERMITTENT MOTION CARTONER

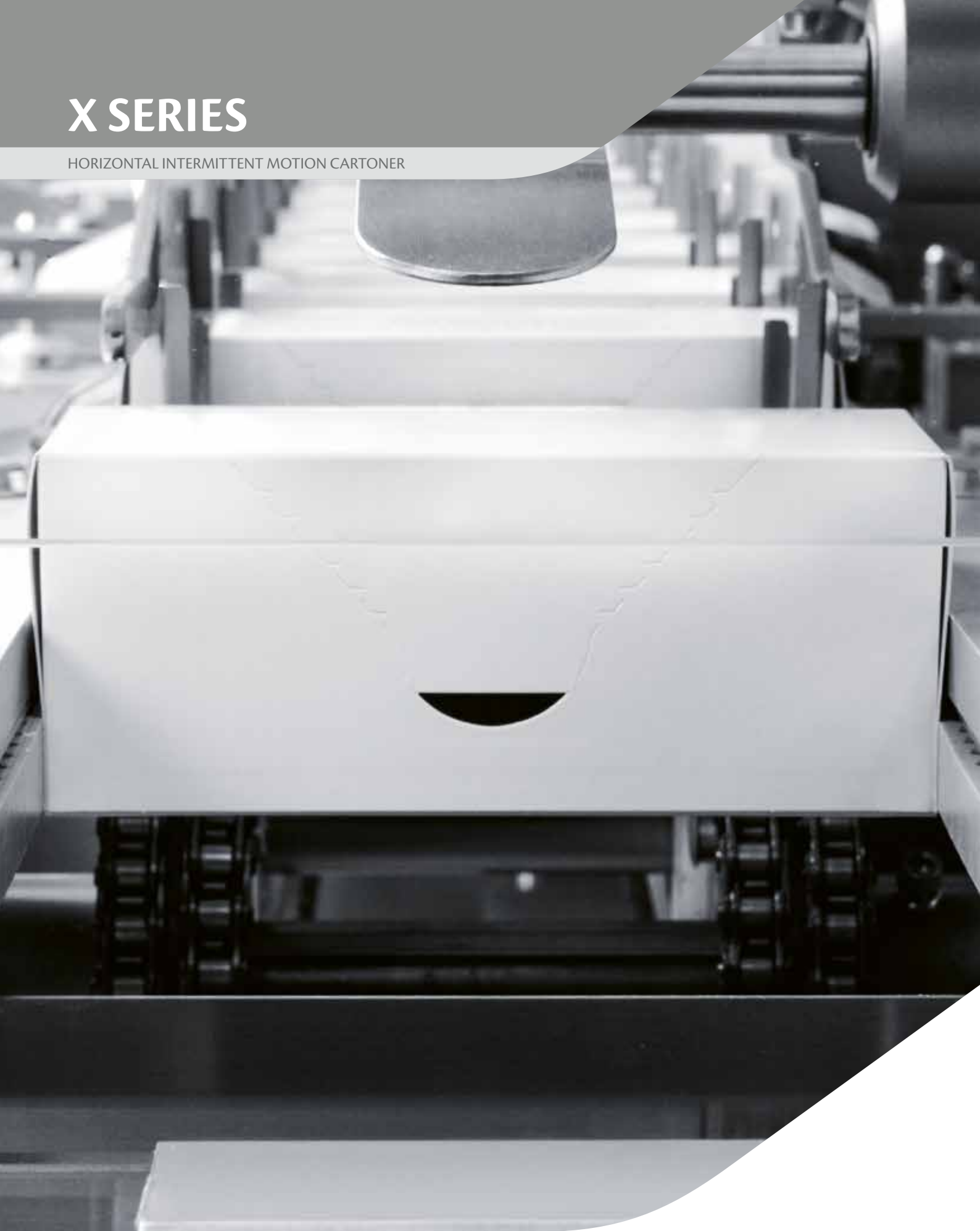

X SERIES MULTIPURPOSE INTERMITTENT MOTION CARTONER

X SERIES IS A MEDIUM SPEED CARTONER DESIGNED SPECIFICALLY TO HANDLE THE WIDEST RANGE OF PRODUCTS AND MATERIALS USED IN PHARMACEUTICAL, NUTRACEUTICAL, PERSONAL & HOME CARE, FOOD AND DIARY SECTORS.

X Series is versatile because can be equipped with any kind of feeding system and can perfectly handle the product along the whole production flow, guaranteeing the best performances. There is no limit of application neither in terms of product fed, nor about carton format since X can handle big cartons and special formats.





BEST PERFORMANCE PRICE RATIO IN ITS CLASS, REALIABILITY, FLEXIBILITY, COMPACTNESS AND QUALITY ARE FULLY GUARANTEED.



X Series' clean and essential design gives full overview of the material workflow, immediate access of all functions and operations while keeping up the efficiency level. A minimum number of size parts assures a rapid changeover.

A COMPACT MACHINE WHICH CAN FIT NEARLY EVERYWHERE.

FOUR VERSIONS ARE AVAILABLE:

- X1
- XL1, FOR LARGE CARTONS
- X2*
- XL2*, FOR LARGE CARTONS

(*servo-driven version)

PRODUCT FEEDING SYSTEMS SUITABLE TO DIFFERENT MARKET



PHARMA PRODUCT FEEDING

- BLISTER
- TRAY
- WALLET
- STRIP (BFS, SUPPOSITORIES ETC.)
- TUBE (RIGID AND SQUEEZABLE)
- AMPOULE
- VIAL
- SYRINGE
- AUTOINJECTOR
- FLOWPACK
- STICK
- SACHET
- INHALER
- MEDICAL DEVICES
- BOTTLE

CUSTOMISED ROBOTIC SOLUTIONS

IMA Safe has developed flexible robotic solutions able to meet even more complex applications and special projects.

Delicate products or that require a specific arrangement inside the carton. Or even the need for extremely frequent format changes where it's just required replacing the robotic head and immediately restart with production. They're just few applications coming from a long experience tailored on customer's business.





COSMETIC PRODUCT FEEDING

- TUBE
- FLOWPACK
- STICK
- SACHET
- BOTTLE
- LIPSTICK
- MASCARA
- PERFUME
- JAR
- LINER

OTHER MARKETS

X Series has been developed to perfectly adapt on different market requests. The long experience on special projects has led this machine to work with completely different products: big dimensions, irregular shapes and delicate consistency are just few examples.



ACCESSORIES FEEDING SYSTEMS



The constant collaboration of IMA R&D with customers has led to the developing of feeding systems dedicated to a wide range of accessories. With the modular concept on which IMA machines are designed, today we're able to pack multi-component presentations inside the carton, maintaining maximum efficiency, regardless of the number of additional accessories. This is possible also thanks to great flexibility in product and accessories handling.



CLOSURES AND TAMPER EVIDENT SOLUTIONS

MAIN CLOSURES

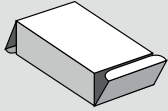

REVERSE TUCK CLOSURE

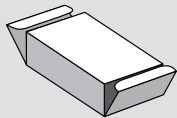

STRAIGHT TUCK CLOSURE

GLUE CLOSURES

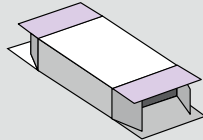

GLUE CLOSURE

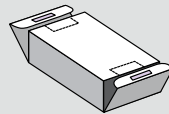

GLUE CLOSURE + TAMPER EVIDENT

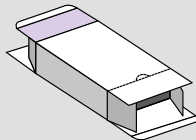

CARTON WITH 4TH FLAP

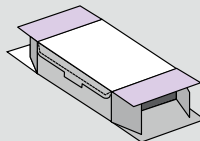

GLUE CLOSURE + HINGED LID

SPECIAL CLOSURES

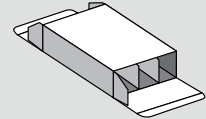

CARTON WITH INNER PARTITION

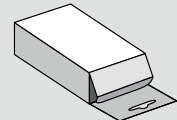

CARTON WITH 5TH PANEL

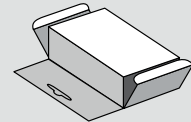

CARTON WITH 5TH PANEL

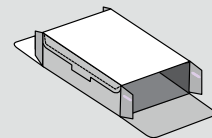

CARTON WITH HINGED LID

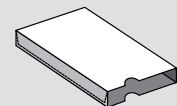

SLEEVE



Glue

TUCK-IN, GLUE OR SPECIAL CLOSURES, LABELING OR PERFORATION: THANKS TO THE VERSATILITY OF OUR CARTONERS, ALL COMMON CLOSURE TYPES CAN BE IMPLEMENTED. CUSTOMISED SOLUTIONS ARE AVAILABLE ON DEMAND.

TAMPER EVIDENT SOLUTIONS

UE Directive 2011/62/EU require the secondary packaging for prescription drugs to be equipped with a tamper verification feature. This means that non-conventional cartons are needed, as an alternative to glue labels. IMA Safe is constantly in touch with the producers of cartons in order to develop and test the solutions for tamper evident.

X SERIES MULTIPURPOSE INTERMITTENT MOTION CARTONER



CARTON MAGAZINE

At a height of 900 mm, the position of the ergonomic, motorised and high capacity carton magazine allow for easy loading of cartons.

CARTON PICK-UP AND POSITIONING

IMA patented carton pick-up and opening positioning: simple and compact, one movement for lifting, controlled opening and positioning of the carton on the conveyor belt. It allows the use of recycled cardboards and even lower quality cartons.

1. CARTON MAGAZINE
2. CARTON PICK-UP AND POSITIONING
3. PRODUCT AND ACCESSORIES INSERTION INTO THE CARTON
4. CODING AND CLOSING





PRODUCT AND ACCESSORIES INSERTION INTO THE CARTON

Product and leaflet are guided and gently transferred into the carton by means of the pusher – or customised movable blade – from the rear side of the machine allowing a full accessibility to the machine from the operator side.



CODING AND CLOSING

The coding stations are located in an area easily accessible to operator. Codes can be applied on both sides of the cartons by embossing, ink-jet or laser. Tuck-in, glue, special and all common closures can be implemented.



HMI

The operator interface has been designed to fully meet 21CFR Part 11 and operator requirements. A computer touch screen, with 16:9 colour monitor and graphical user interface, enables easy and intuitive management of the machine's production and status. The computerised system manages the bar code reader, OCV, and OCR which are completely integrated into the single HMI. Production data and statistics, troubleshooting, including changeover instructions, maintenance and manuals can be obtained through the HMI screen. Troubleshooting and maintenance can be done also via modem connection. Reconciliation of production data, to facilitate production batch closing, is possible from the machine interface and via Ethernet connection.

LEAFLET AND BOOKLET FEEDING SYSTEMS

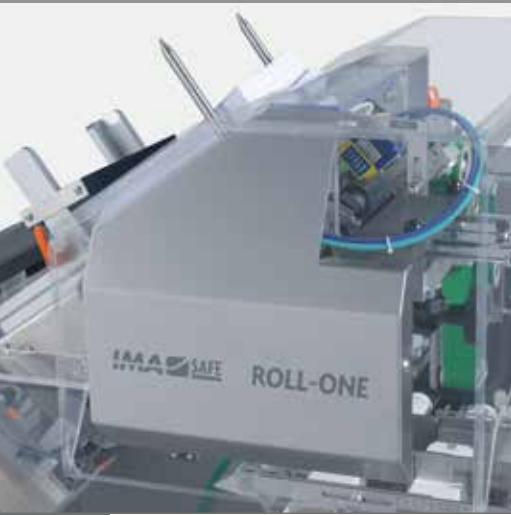

IMA ROLL-ONE, LEAFLET FOLDING UNIT

The IMA patented leaflet folding unit is designed to fold flat sheets using an innovative folding system that eliminates the problems of adjustment related to the leaflet thickness.

In order to change the width of the folded sheet it is enough to change only one part. The whole operation could not be simpler taking less than a minute. IMA ROLL-ONE is practical, logical, reproducible and quiet.



ALL KIND OF LEAFLETS
FOLDERS CAN BE INSTALLED
FOR FLAT, PRE-FOLDED AND
LEAFLETS FROM REEL.



Perfect integration with IMA booklet feeders



X SERIES MULTIPURPOSE INTERMITTENT MOTION CARTONER

SIZE CHANGEOVER

Extremely easy, intuitive and quick size changeover with adjustments through indicators.



ONE-STOP-SHOP SUPPLIER

When we say "one-stop-shop supplier" we mean that IMA is next to the client from the processing of his product up to shipment to the final distribution. Only one entity, so many specialists and technologies. Complete packaging lines area designed on customer needs giving life even to the most complex projects.

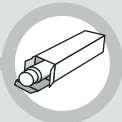
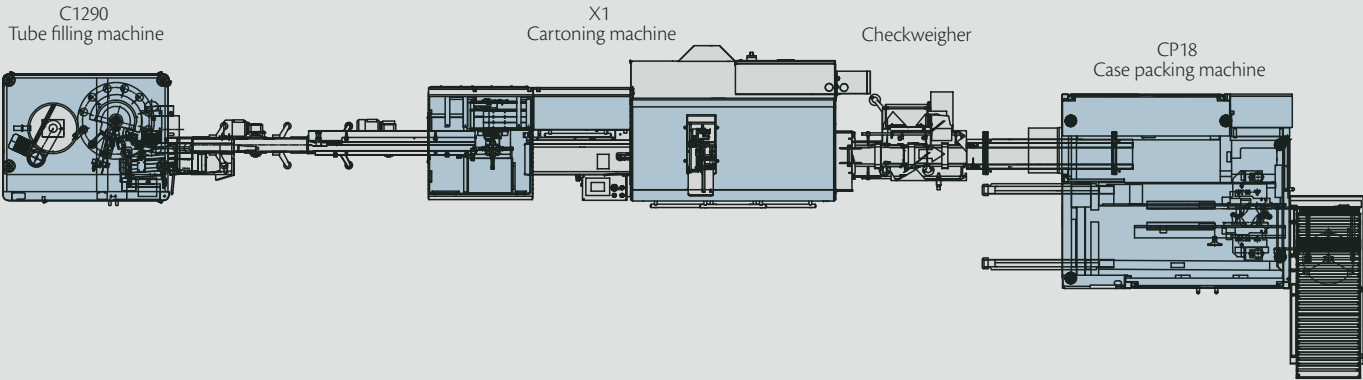

TRACK & TRACE SOLUTIONS

TRACK & TRACE AND SERIALIZATION

ONE LINE - ONE SOLUTION - ONE SUPPLIER

Together with IMA Life and IMA BFB, IMA Safe works actively to find the most functional and GMP solutions starting from the primary packaging (blister, bottles or tubes etc...) to the secondary packaging (cartons, bundles, cases and pallets...). IMA Group is your best partner for supplying complete serialized track and trace lines.



IMA INTEGRATED MODULE FOR SERIALIZATION

Integrated module to apply camera, laser or ink-jet systems. It is the ideal solution to have a shorter line and higher efficiency because of less units in the line and a constant control of the carton in the tooth belt transport.

Side printing and camera inspection



Top printing and camera inspection



IMA SAFE AFTER SALES SERVICE

IMA Safe's goal is to become a partner for its customers. To respond to every requirement with customised solutions and guarantee maximum flexibility and professionalism.

The relationship IMA Safe builds with its customers does not end with a sale. With after-sales service tailored to the customer's specific needs, it lasts for the duration of the machine's lifespan. That's why IMA Safe can count on high levels of customer retention around the world.



SUPPORT SERVICES

- Telephone online
- On site service
- Remote support assistance
- Production support
- Relocation service
- Spare parts



PRODUCTION SERVICES

- Mechanical and electrical upgrades
- Technical audit



MAINTENANCE SERVICES

- Single inspection by technician on site
- Remote experts consultation
- Maintenance optimization strategy
- Calibration support
- E-check
- On site practical maintenance training



TRAINING SERVICES

- Training programs
- Multimedia training



FORMAT PARTS SERVICES

- Format parts



IMA REMOTE ASSISTANCE SOLUTIONS

IMA Digital Service Solutions aim to offer remote support and to restore production quickly. Through selected tools, an IMA expert remote is able to promptly support the resolution of technical problems occurred on the machine.

Quick-kit

Quick-Kit Solutions consists of an action camera installed on headphones. The technician is able to frame what he is directly observing, speaking in real-time with the remote expert and receiving at the same time audio guidelines to carry on the operations.

Hololens 2

Hololens 2 allows combining different benefits through the use of a new generation viewer. It becomes possible to frame the surrounding environment directly by integrating elements of augmented reality (drawings, diagrams, documentation) shared by the IMA Expert remote.

TECHNICAL DATA

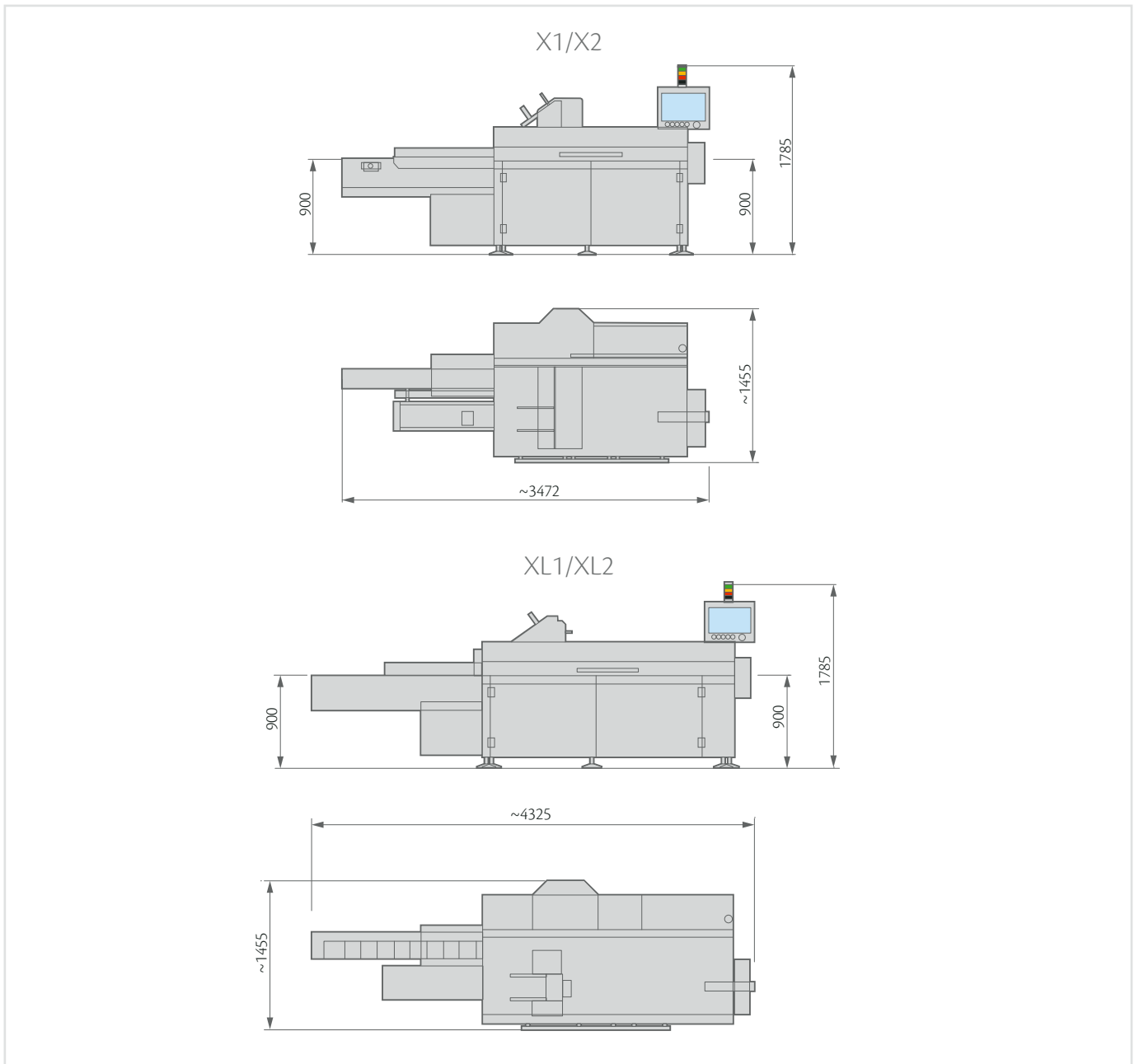

The dimensions are indicative and can vary depending on the optional groups chosen and machine lay-out

	WIDTH (A)	HEIGHT (B)	LENGTH (H)	A+B MAX	PRODUCTION SPEED
X1 - X2*	15 - 105 mm	15 - 105 mm	65 - 220 mm	195	140 cartons/min
XL1 - XL2*	15 - 165 mm	15 - 105 mm	65 - 220 mm	240	90 cartons/min

*Servo-driven version

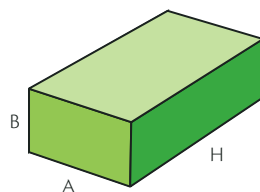

ima.it

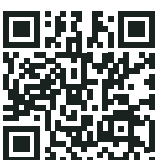

IMA S.p.A. Unipersonale
IMA SAFE division
Via I Maggio 14/16 - 40064 Ozzano dell'Emilia (Bologna) - Italy
Tel. +39 051 6514111 - Fax +39 051 6514743
mktg.packaging@ima.it

